

KÄRCHER

makes a difference



**KÄRCHER TANK INTERIOR CLEANING
– WE ARE YOUR PARTNER**

WE ARE SURE YOU KNOW KÄRCHER ...



FAMILY OWNED COMPANY



MILESTONES

1935



Foundation of company by Alfred Kärcher.

1950



Development of the first European hot-water high-pressure cleaner.

1959



Irene Kärcher takes over the management of the company after her husband's death.

1960s



Strategy of diversification: new range of products such as heaters, steam generators, building cladding and hollow plastic vessels.

Start of international orientation and first subsidiaries.

1974



Strategy of concentration on the core business of high-pressure cleaning. Colour changed from blue to yellow.

MILESTONES

1980



Strategy of concentration on cleaning.

1984



Entry into the consumer market with the first portable high-pressure cleaner.

1987



Development of the first own scrubber drier.

1989



Death of Irene Kärcher.

1993



Development of the first own sweeper.

MILESTONES

2001



Development of the business unit “Water Treatment”.

2007



Expansion into garden products.

2011



Strengthening of market position in the fields of municipal and industrial products.



2013



Change of colour of all products for professional users to anthracite.

PEOPLE MAKE OUR COMPANY

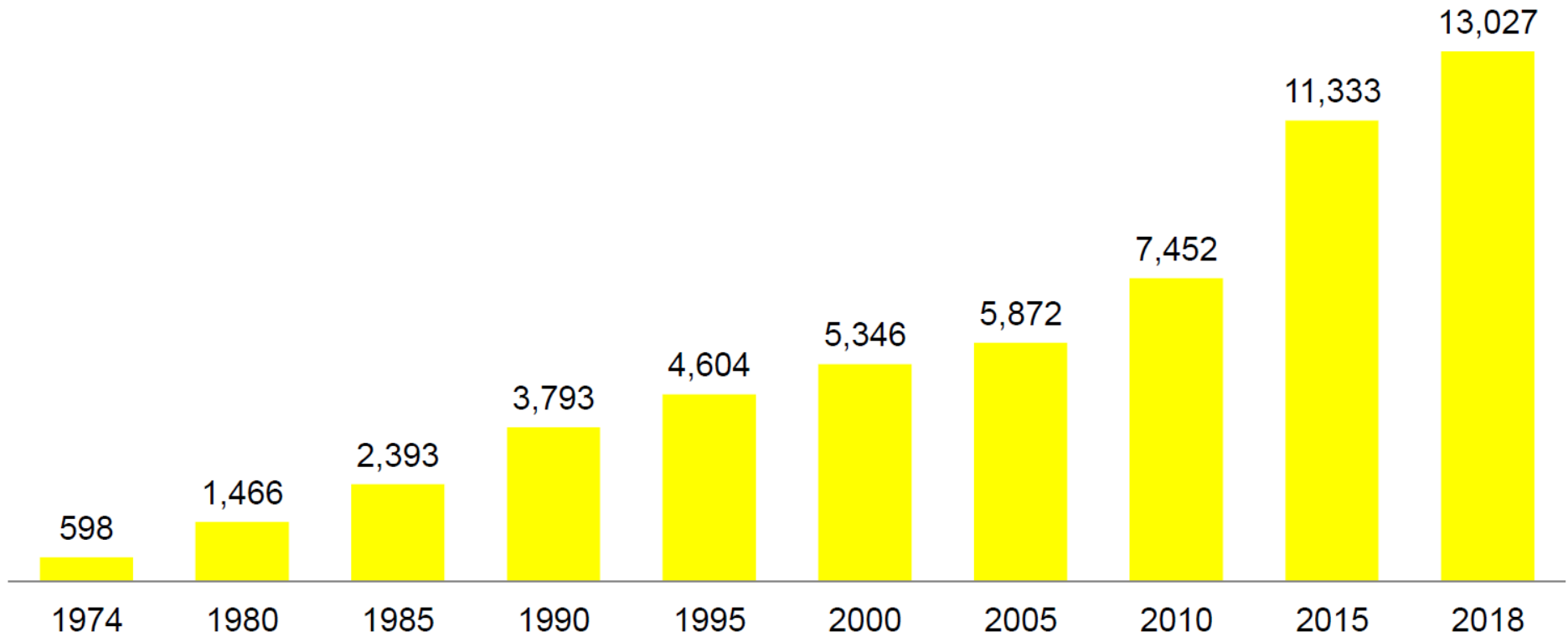

WE ARE THE INNOVATION LEADER IN CLEANING TECHNOLOGY

More than 1,000 employees working in R&D.

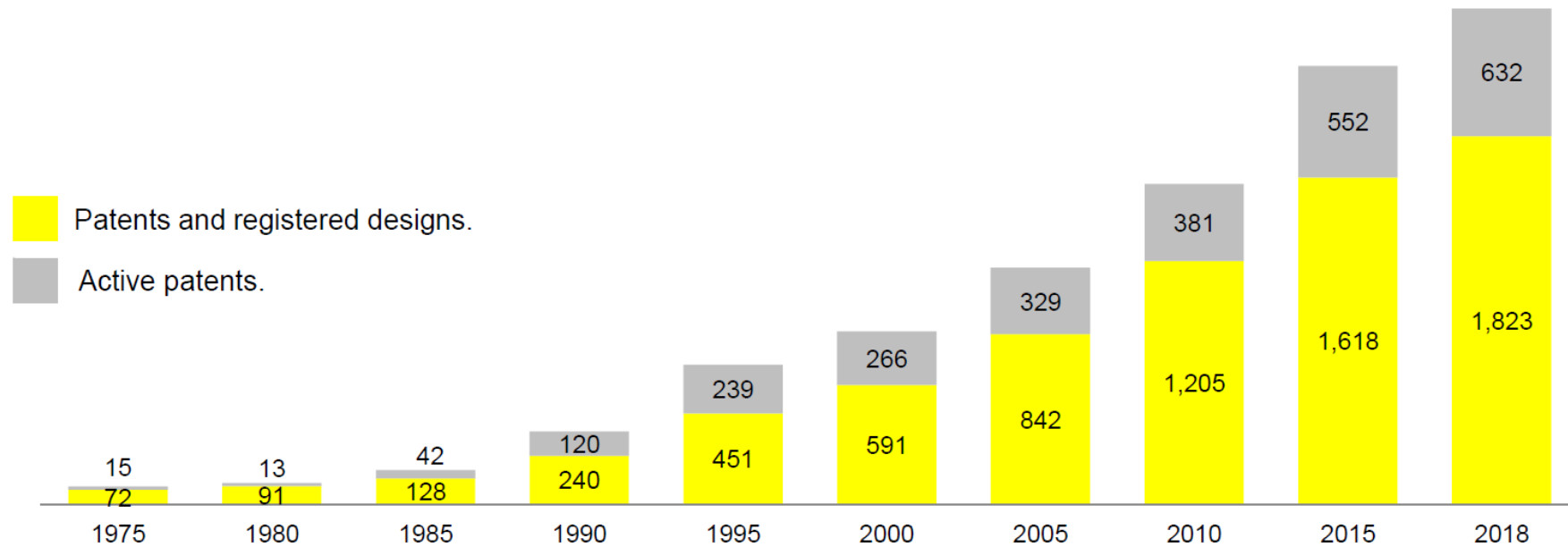

WE ARE SURE YOU KNOW KÄRCHER ...

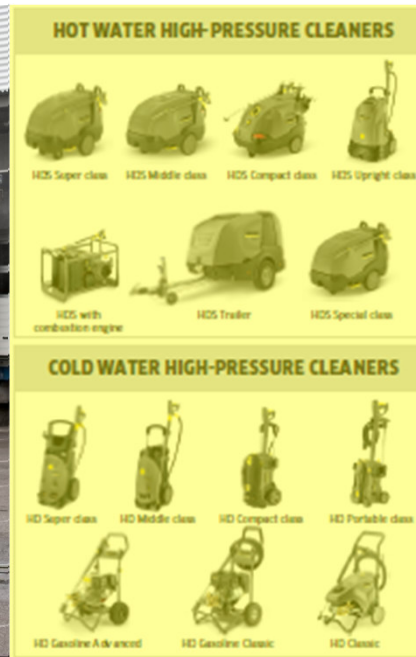

... BUT WE CAN DO SO MUCH MORE!!

WIDE RANGE OF PROFESSIONAL PRODUCTS

| | | | | | | |
|---|--|---|---|---|---|----------------------------------|
| HOT WATER HIGH-PRESSURE CLEANERS | WET AND DRY VACUUM CLEANERS | CARPET CLEANERS | SCRUBBERS/SCRUBBER DRIERS | VACUUM SWEEPERS AND MUNICIPAL IMPLEMENT CARRIERS | SYSTEM SOLUTION FOR CONTAINER CLEANING | ecozero ecoEfficiency |
| COLD WATER HIGH-PRESSURE CLEANERS | INDUSTRIAL VACUUMS | CARPET CLEANERS ACCESSORIES/ADDITIONS | WALK BEHIND 40 LITRE CLASS | MANUAL IMPLEMENT CARRIERS COMPACT CLASS | ecozero ecoEfficiency | CONNECTED CLEANING |
| STATIONARY HIGH-PRESSURE CLEANERS | DRY VACUUM CLEANERS | STEAM CLEANERS AND STEAM VACUUM CLEANERS | COMPACT 50 TO 75 LITRE CLASS | PARK & CITY SOLUTIONS | WATER RECLAMATION | ecozero ecoEfficiency |
| ULTRA HIGH-PRESSURE CLEANERS | VACUUM CLEANERS ACCESSORIES/ADDITIONS | MANUAL CLEANING EQUIPMENT | WALK BEHIND 120 LITRE CLASS | VEHICLE CLEANING | DRY ICE CLEANING | ecozero ecoEfficiency |
| HIGH-PRESSURE CLEANERS ACCESSORIES | DRINKING WATER | CLEANING AND CARE AGENTS - FOR ANY APPLICATION | WALK BEHIND 80 LITRE CLASS | VEHICLE CLEANING | DRY ICE CLEANING | ecozero ecoEfficiency |
| Preservation 3 | CarpetPro 3 | SurfacePro 3 | Walkbehind 3 | PartPro 3 | WaterPro 3 | ServicePro 3 |

THE SOLUTION ALWAYS STARTS AT YOU

Container type / size

Contamination / product inside



Kärcher solution

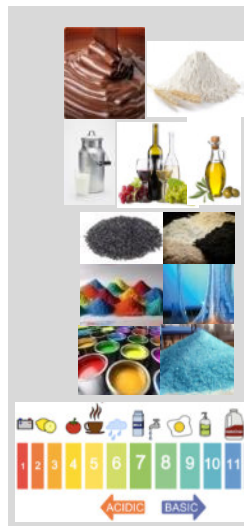

| High-pressure pumps | Interior cleaning heads | Hot water generators | Detergents / cleaning agents | Accessories | Controls |
|---------------------|-------------------------|---|------------------------------|-----------------------------------|---------------------------------------|
| HD/HDS | ICH 80/16 Ps | HWE | RM 870 | Drying | In combination with HDC |
| HDI | ICH 140/4 Ps F2 | | RM 875 | Drying with heat exchanger | Without electrical cabinet |
| HDC | HKF 200 | warm water generator and plate heat exchanger | RM 880 | Water softener | 1: remote control without display |
| HDCI | HKF 50 | | RM 885 | Balancer | 2: remote control with display |
| Woma | | | | Ball valves high-pressure / steam | 3: PC for operation and visualisation |



IBC

KÄRCHER



ISO - CONTAINER

KÄRCHER



ROAD TANKER

KÄRCHER



SILO TANKER





KÄRCHER



RAILROAD TANKER

KÄRCHER

IN-HOUSE KNOWLEDGE OF ALL ASPECTS OF SINNER CYCLE

-  Mechanical effect
-  Temperature
-  Cleaning agent
-  Time

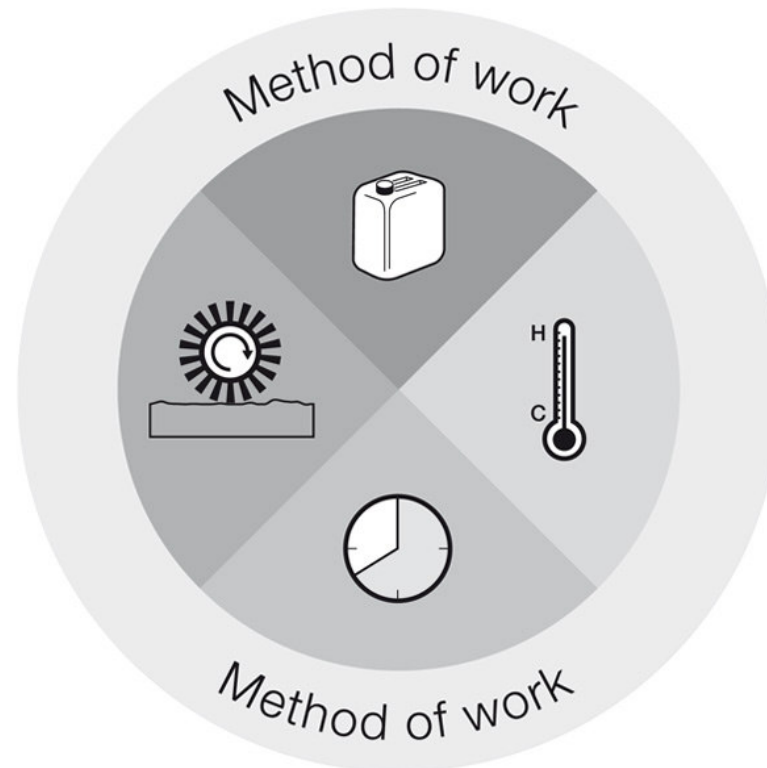

„The cleaning circle by Sinner shows

which factors play in cleaning together

to achieve a perfect finish!”

KÄRCHER = CUSTOM SOLUTION FROM MODULAR COMPONENTS



Transport Logistic | Munich 2017

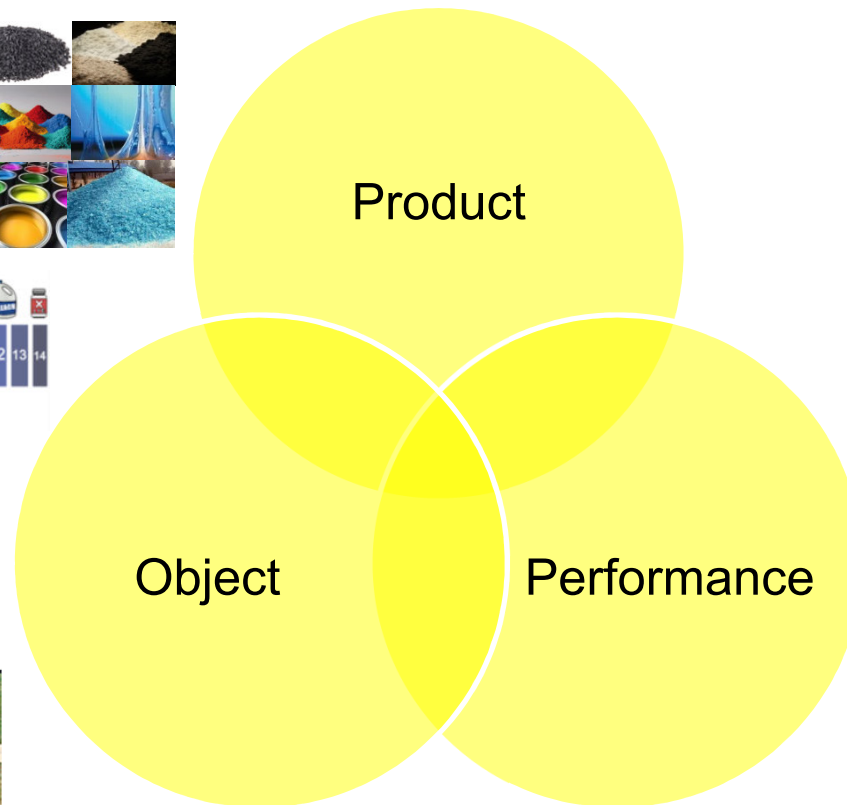

- Pressure (50 – 1500 bar)
- Flow Rate (no limits!)
- Clean Objects per hour
- Hot Water / Steam
- Cleaning Agents / Dosing
- Ex proof / ATEX
- Drying / Evacuation
- Recycling / Circulation
- Energy Recovery
- Waste Water Management
- Control Systems
- Manual / Automatic
- Monitoring / Data Exchange
- Certificates
- Piping / Installation
- Commissioning / Start up
- Rebuild / Service



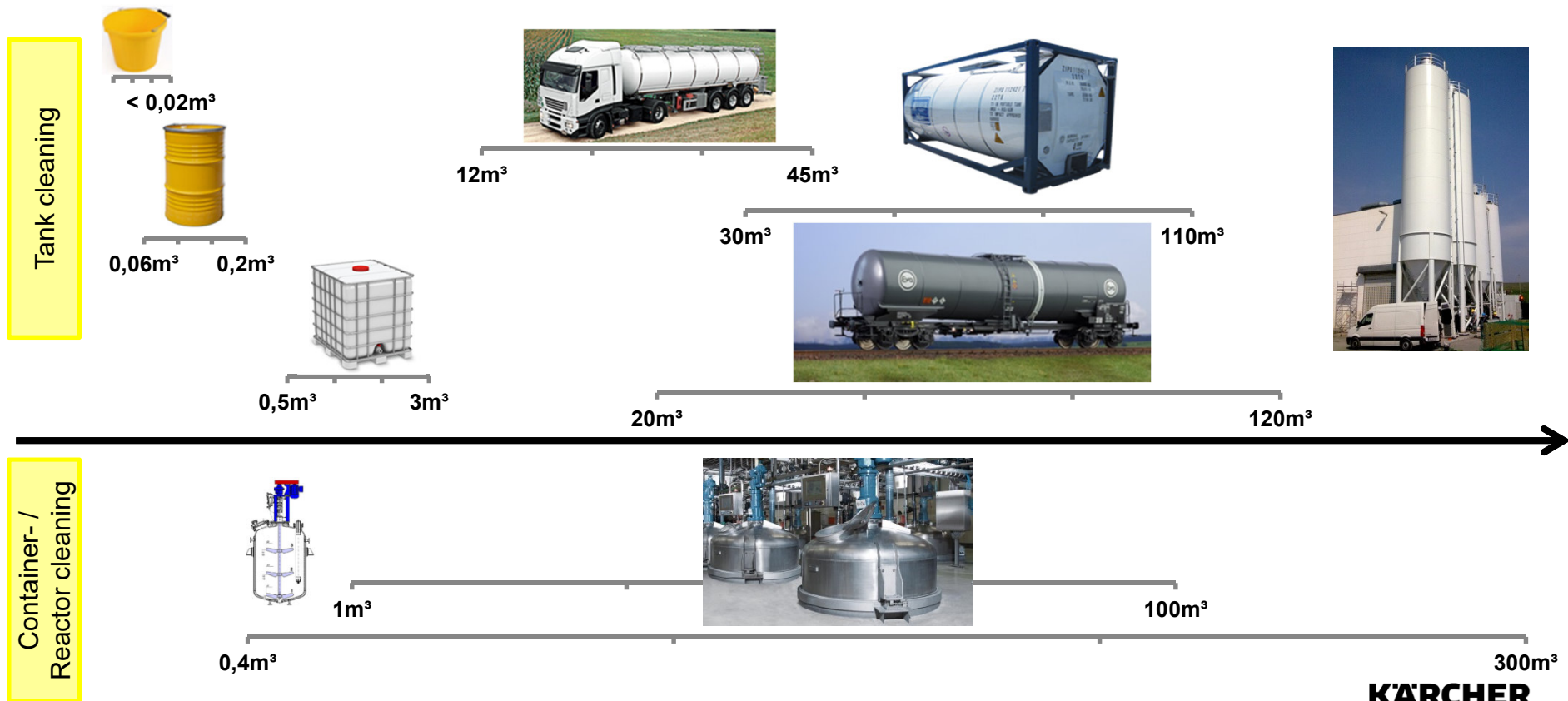

- ...

KÄRCHER

TO FIT YOUR CLEANING REQUIREMENT

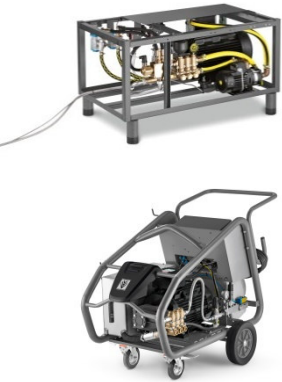

OUR IN-HOUSE DEVELOPED COMPONENTS

| Interior cleaning heads | High-pressure pumps | Hot water generators | Controls | Accessories (e.g. drying) | Cleaning agents |
|--|--|---|--|--|--|
|  |  |  |  |  |  |

ARE COMBINED INTO YOUR SOLUTION

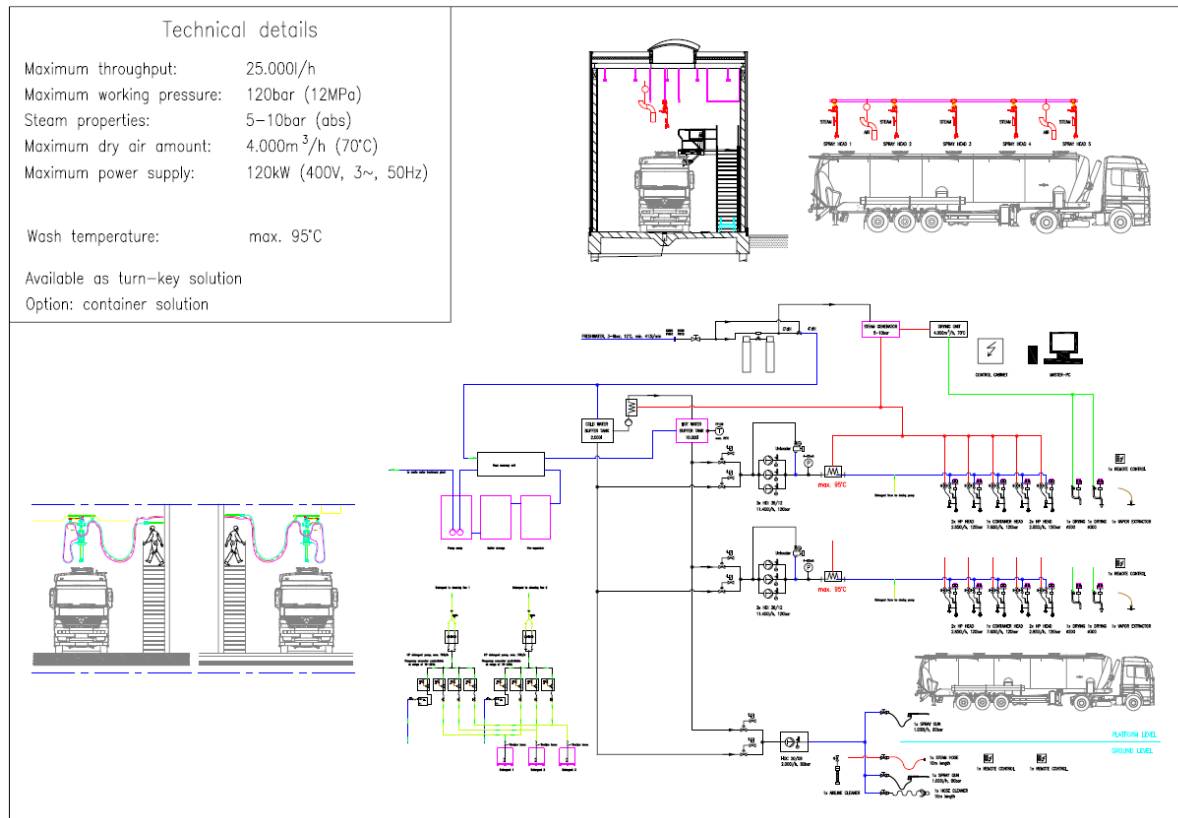





WITHOUT PEOPLE ENTERING THE TANK TO CLEAN



RELIABILITY = EXCELLENT RESULTS EVERY TIME

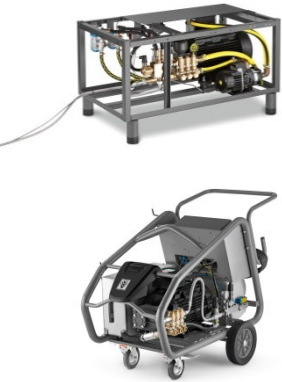

RELIABILITY = SOLUTIONS WITH OUR COMPONENTS

| Interior cleaning heads | High-pressure pumps | Hot water generators | Controls | Accessories (e.g. drying) | Cleaning agents |
|--|--|---|--|--|--|
|  |  |  |  |  |  |

THEREFORE WE NOT ONLY ENGINEER SOLUTIONS

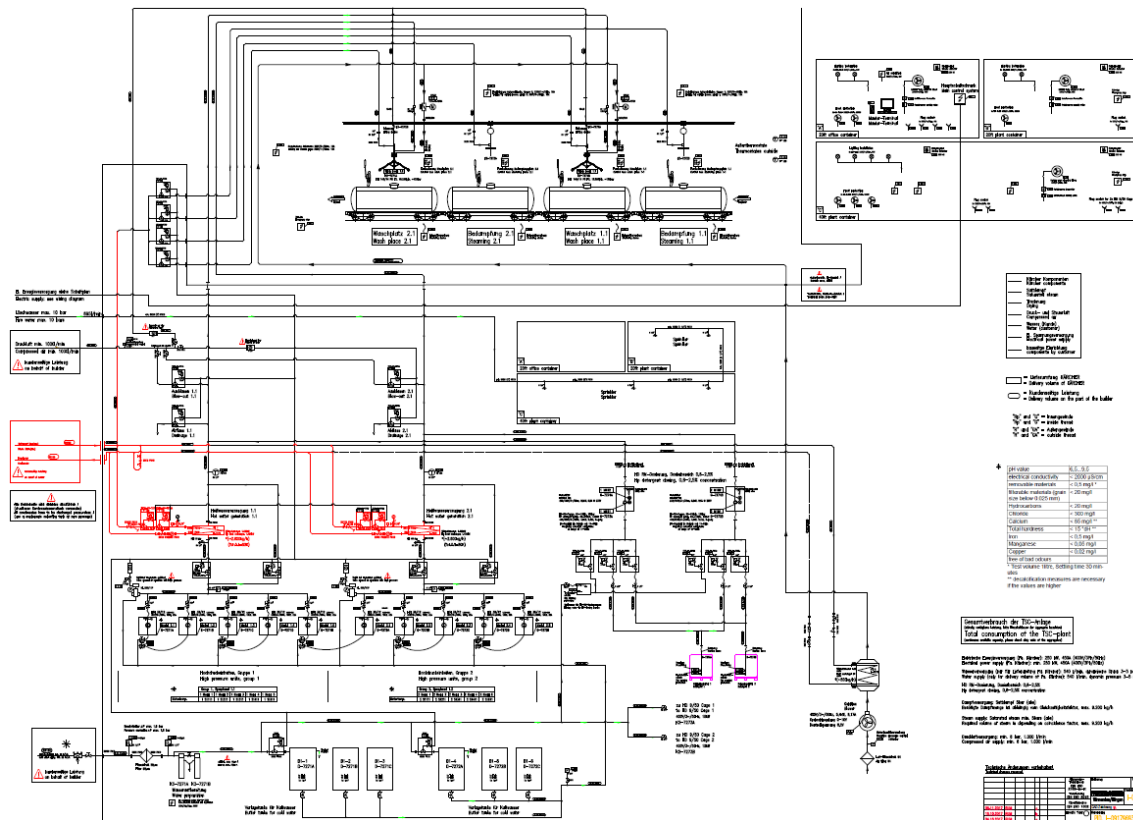

WE DEVELOP COMPONENTS & SOLUTIONS



Old HK S100

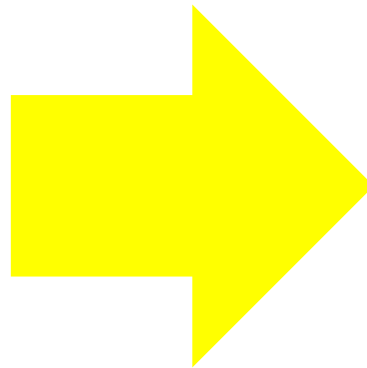

New ICHPS

KÄRCHER

WE DEVELOP COMPONENTS & SOLUTIONS

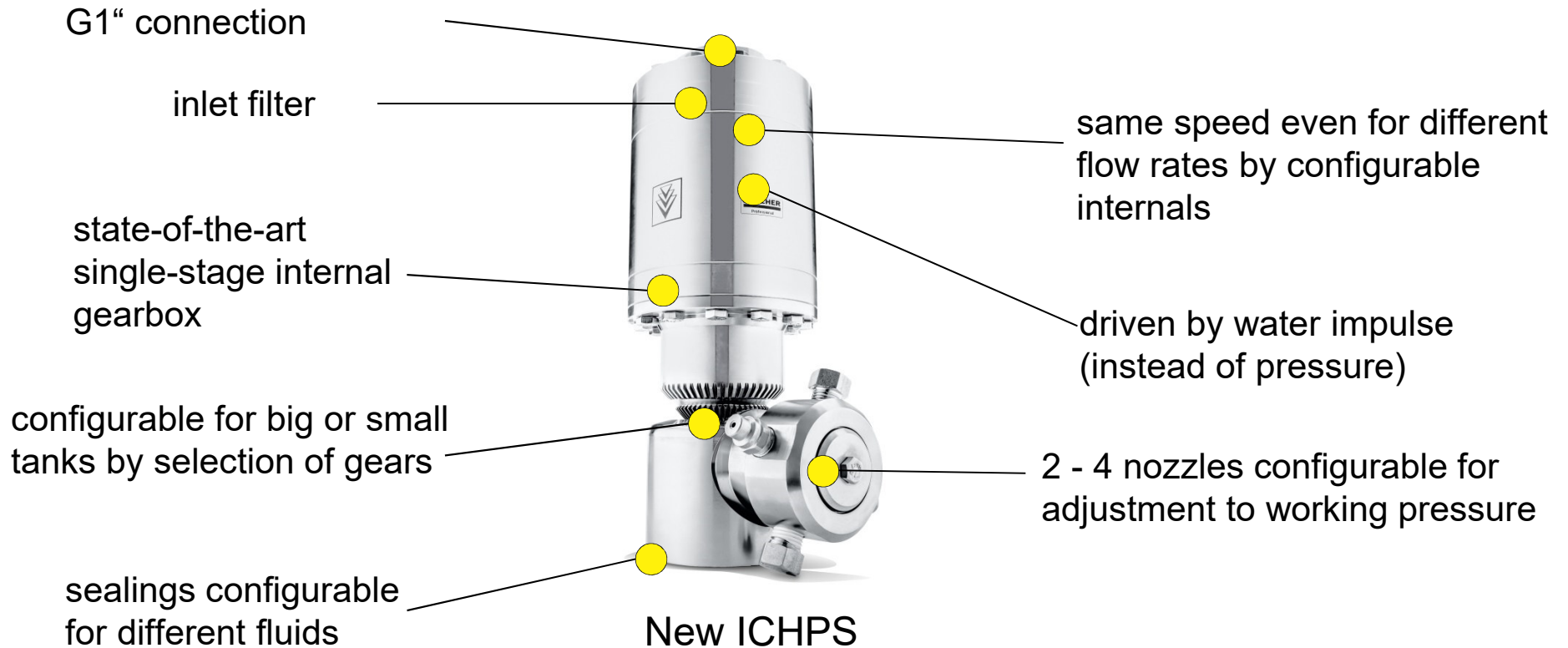

TO CREATE RELIABLE CLEANING RESULTS

Due to design and calculation of internal gear ratios the cleaning result of our cleaning head is different:

Competition:

- free areas
- some double / triple impact
- not homogenous

= longer cleaning time required

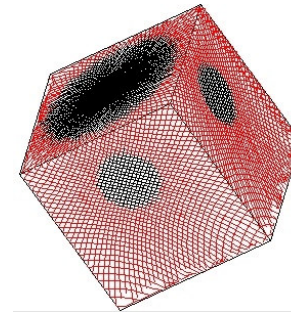
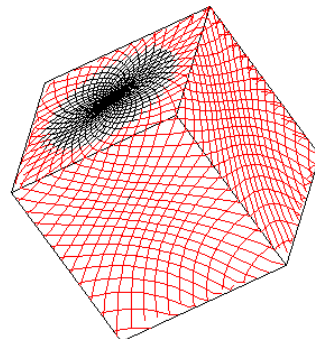

Kärcher:

- nearly 100% covered
- homogenous

= short / effective cleaning

WE DEVELOP COMPONENTS & SOLUTIONS BASED ON YOUR NEEDS

Container type / size

Contamination / product inside



Kärcher solution

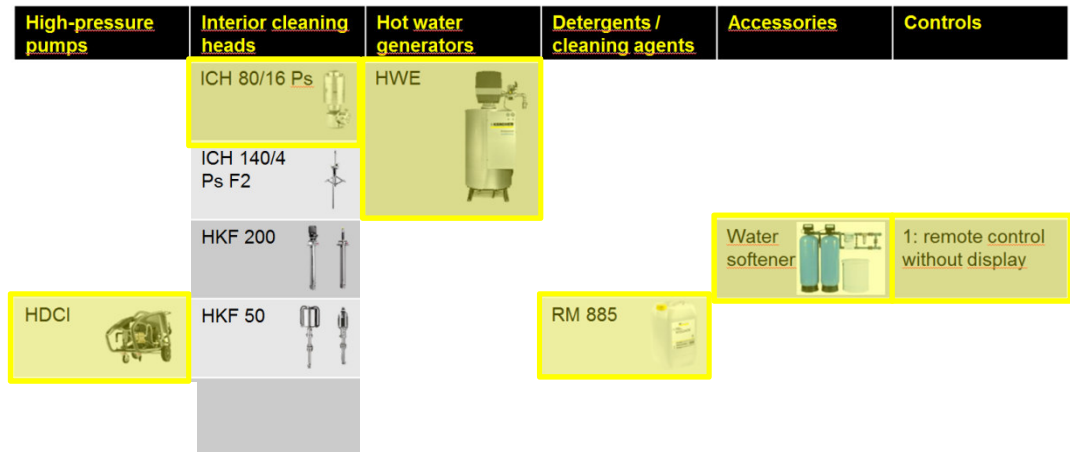

WHAT IS A SOLUTION?



SOLUTION = GET IT DONE WITH AS LITTLE PARTS AS NECESSARY

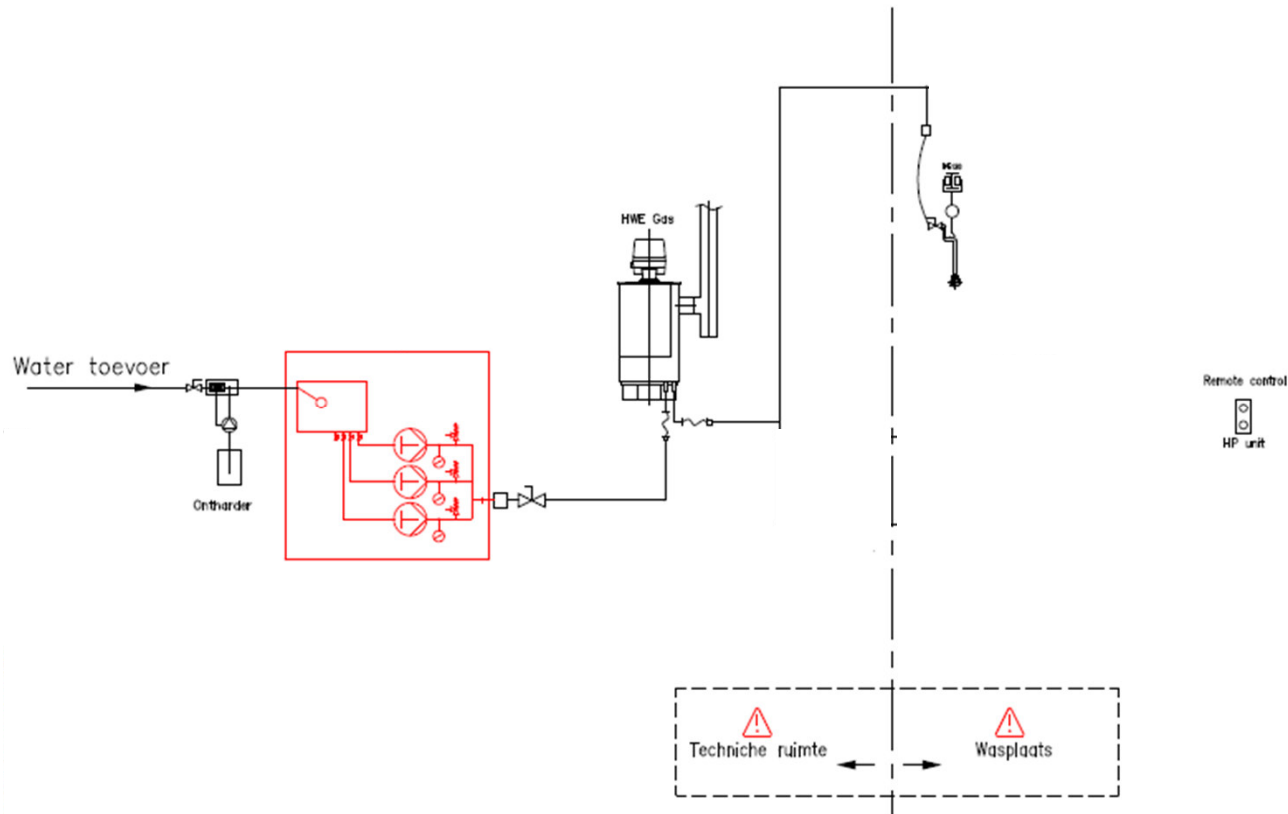

SOLUTION = GET IT DONE WITH AS LITTLE PARTS AS NECESSARY

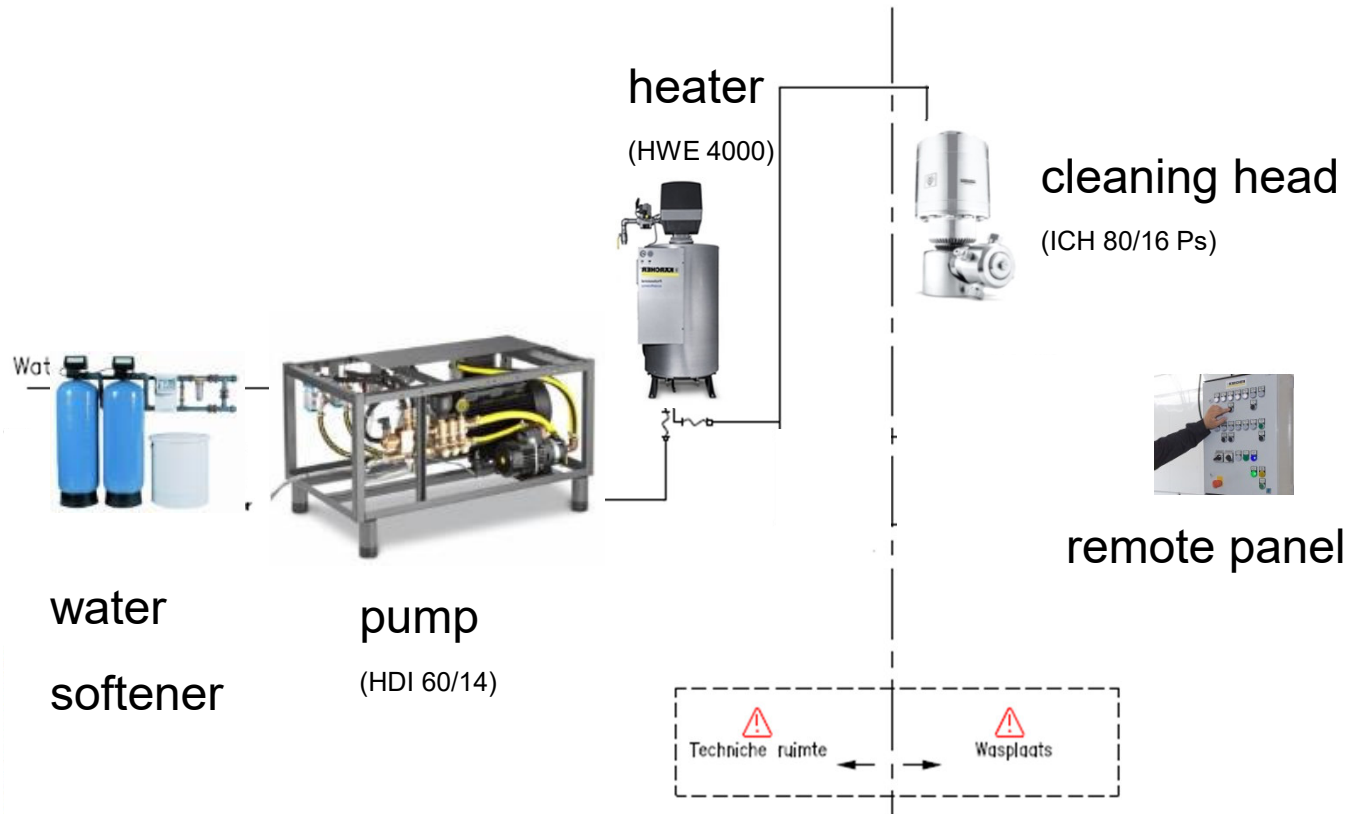

KÄRCHER IS THE SERVICE PROVIDER WORLD-WIDE

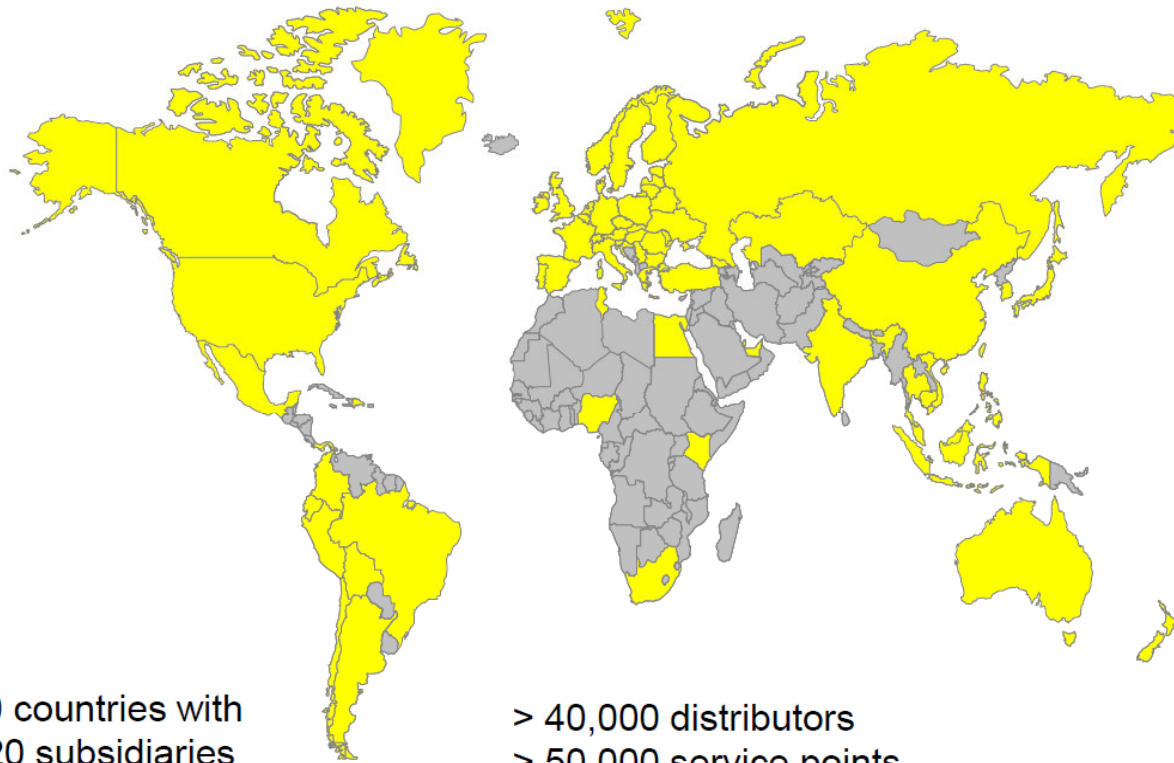

70 countries with
> 120 subsidiaries
> 400 locations

> 40,000 distributors
> 50,000 service points

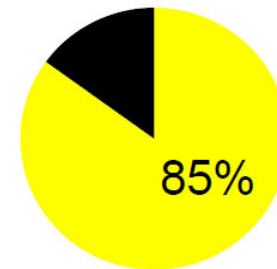

Sales abroad

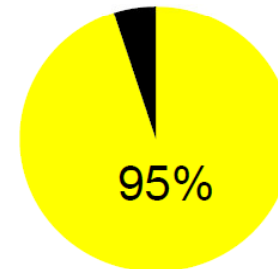

of world GDP covered

PROVEN BY MORE THAN 250 TANK CLEANING PROJECTS WORLD-WIDE



Global Customer benefit:

- Professional support
- Reliable cleaning result
- Effective operation
- High degree of safety at work

KÄRCHER = YOUR GLOBAL PARTNER, ASK FOR MORE !

Rob Raeymaekers

Technical Sales Engineer

Product Management Engineering /
Industrial Projects

T. +32 470103321

Rob.Raeymaekers@be.kaercher.com



Stephan Wolff

Manager

Product Management Engineering /
Industrial Projects

T. +49 7195 14 - 4380

Stephan.Wolff@de.kaercher.com

